

Aqua Zoom



Zoom Aqua Quill Shape Dimensions(mm):

3200 x 1155 Max

Pole below water 840mm

Zoom Aqua Feather Shape Dimensions(mm):

3700 x 785 Max

Pole below water 840mm

Min water depth 1200mm Max water Depth 3400mm



NB: Before use in water tether to a secure point with easy access for removing from water using the tether rope supplied, Also be sure to move base bracket upto joint on pole B.

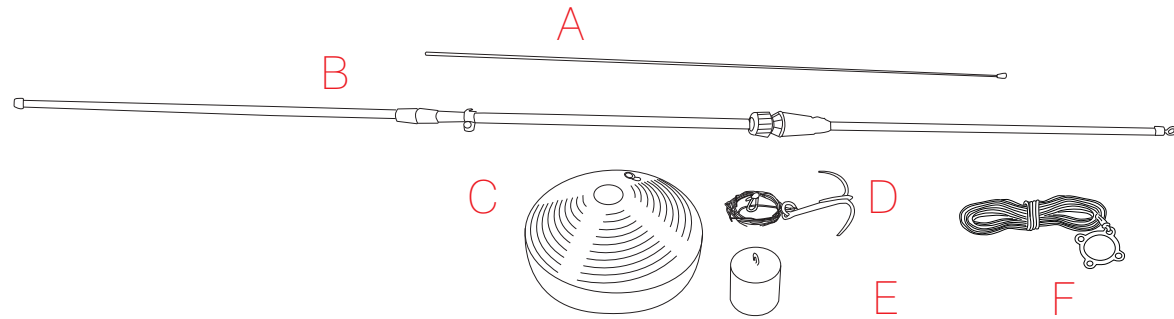

1

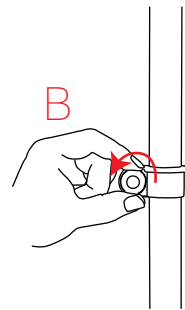

2

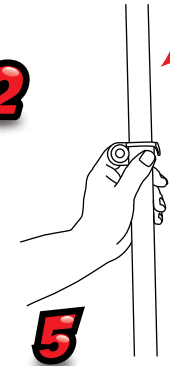

3

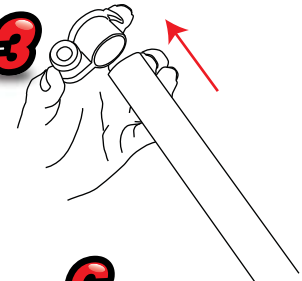

4

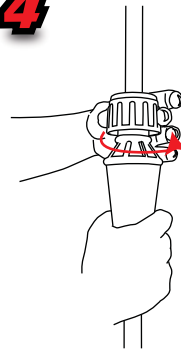

5

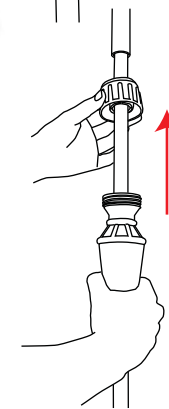

6

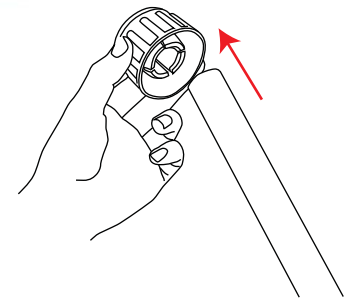

Aqua Zoom

