

⚠️ NOTA: NELLA VERSIONE GRAFICA CON ZIP SALTARE ALLO STEP 5 E POI CONTINUARE CON GLI STEP 3 & 4

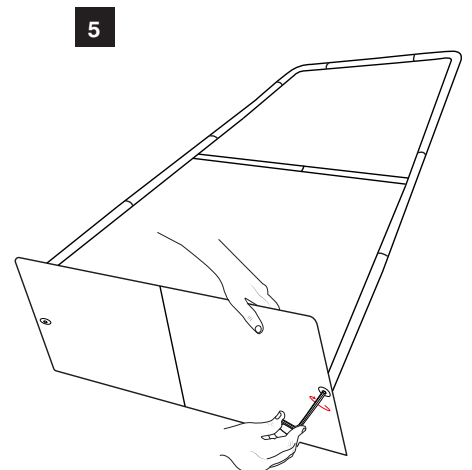

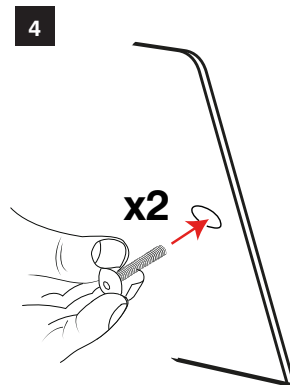

6a

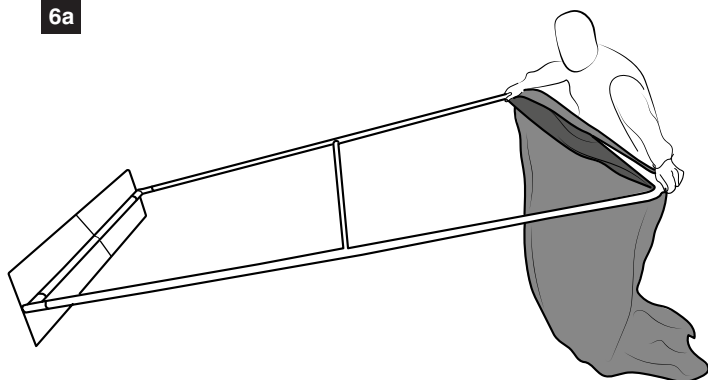

NOTA: INSTALLARE LA GRAFICA E CHIUDERE LA ZIP PRIMA DI FISSARE LA BASE

6b

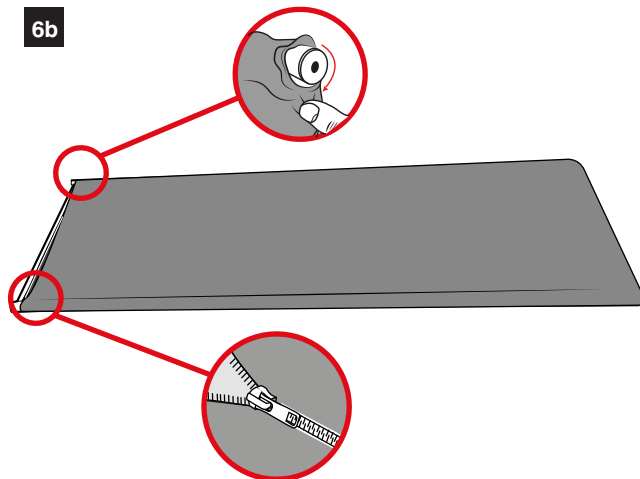

7

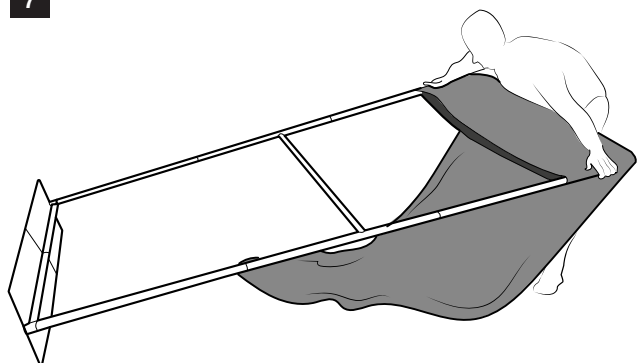

8

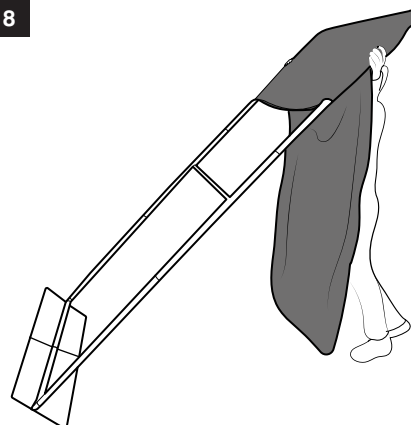

9

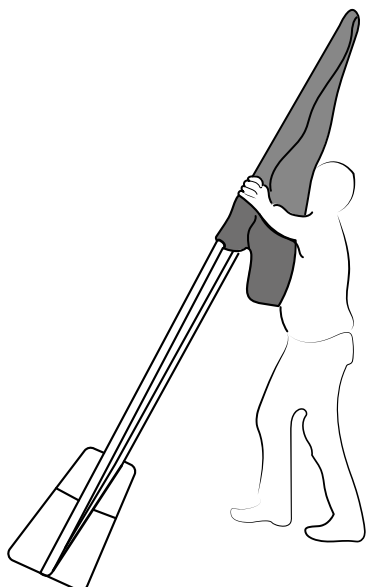

10

